

SUTCO® BIOLOGICAL TREATMENT SYSTEMS.

BIOWASTE-COMPOSTING PROCESS LINE COMPOSTING SYSTEM BIOFIX

CONSERVING RESOURCES THROUGH
INNOVATIVE ENVIRONMENTAL TECHNOLOGY.



SYSTEM BIOFIX

The Biofix system processes biodegradable waste in an automated and dynamic process to recycle it into a high-quality compost or produce landfill material complying with the legal requirements, laid down in the various directives.

Thanks to its modular design, different biological waste can be treated separately. Starting with two bins, an expansion of the number of bins is possible. Even the length of the bins is flexible. Normally, a length of approx. 48 m is used. Plants of up to 50,000 Mg/a and more can be implemented.

DELIVERY OF WASTE

Vehicles delivering waste are weighed, and the waste types, - quantities and - origins are recorded. There-after the vehicles are offloaded. Private and low-volume waste may be delivered to separate containers provided in specially designated areas, e.g. amenity sites.



THE SUTCO® BIO-WASTE COMPOSTING PROCESS

The biological waste treatment plant is based on the Sutco Biofix process. The treatment of the separately collected biological and "green" waste is shown here.

The suppliers dump their waste into the storage bunker of the delivery hall. The storage bunker is sufficiently sized to accept a two days' maximum waste delivery. Enough manoeuvring space for wheel loader operation and for the unloading collecting vehicles is available even in case of a maximum supply of biological and garden waste has been reached. A first eye-inspection of the input material is made in the storage bunker. Oversize and hazardous material interfering with the process shall be removed or waste deliveries with harmful or interfering harmful substances can be separated. If necessary, the wheel loader for the delivery area piles the waste in the delivery hall or delivers it to the chain conveyor with its feeding bunker. The waste is reclaimed from the feeding bunker by a speed-controlled chain conveyor onto the inclined conveyor for biological waste, and another inclined conveyor is used for charging the trommel screen for biological waste.

The screen overflow is conveyed to the Sutco Mix-Shredder, using conveyors. The screen overflow from

the trommel screen is conveyed passing a magnetic separator to the sorting cabin, in which hazardous and reject materials are manually removed and then dumped into waste containers. The number of persons needed on the sorting platform depends on the amount and quality of the input material. The throughput from the sorting platform is conveyed from the sorting cabin to the Mix-Shredder.

A bucket wheel loader is used to charge the variably speed-controlled conveyor with coarse-crushed garden waste. Structural material to improve aeration of the windrows during composting is added into the Mix-Shredder by bringing together the trommel screen overflow cleaned from hazardous and reject material, the organic residuals from the compost treatment (see below) and the garden "green" waste. At the front face of the discharge conveyor for the screening overflow an over-belt magnetic separator is attached. The magnetic separators cut ferrous metals from the waste stream and throw them into a container via a chute. From the Mix-Shredder the waste material is conveyed to the inclined conveyors to the feeding system in the composting hall.

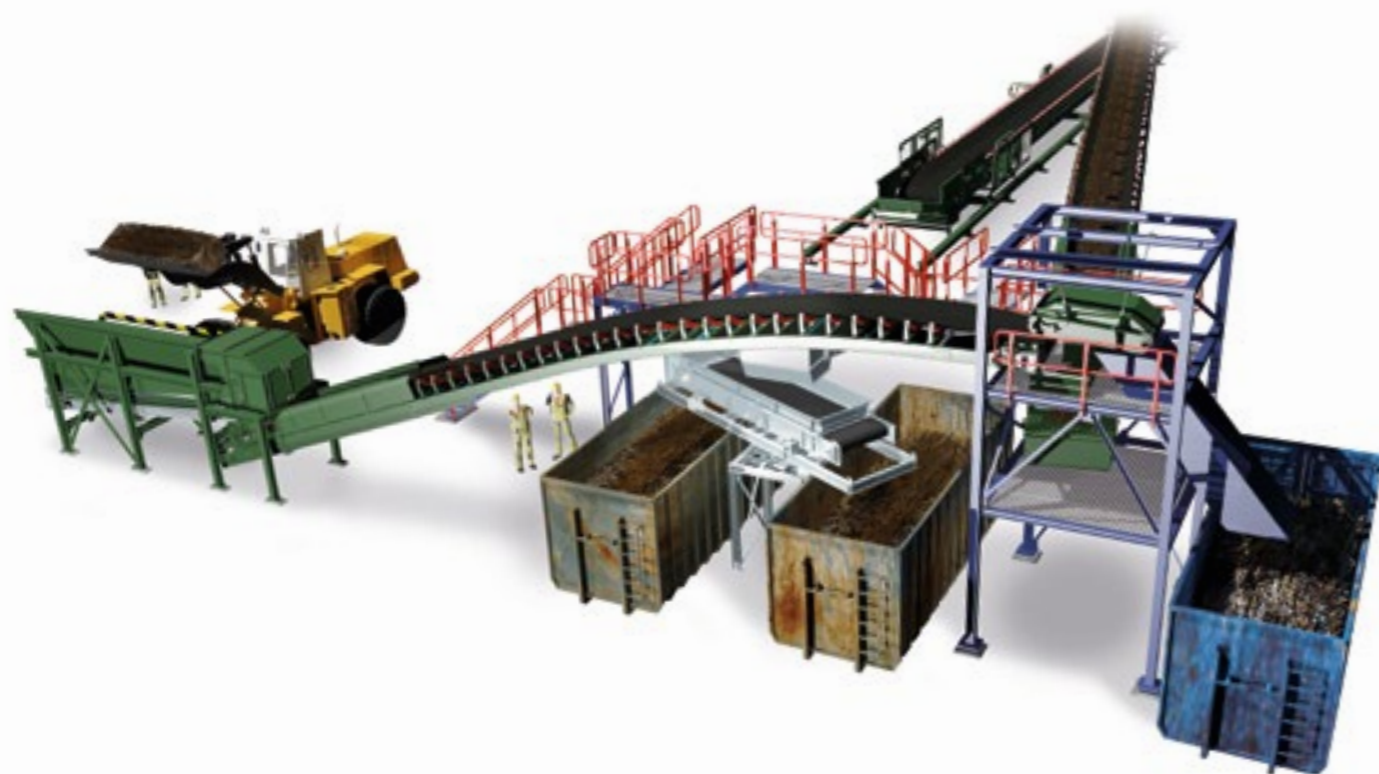

BIOFIX DYNAMIC LINE COMPOSTING

The Biofix composting bin reactors for intensive composting are built in a single-nave hall. Four double bins in modular designs are there for the throughput volume of the biological treatment plant. Each composting bin is divided into four composting sections and equipped with a slatted concrete tile floor which is used to aerate the composting material and to discharge the condensate and leachate water. The individual composting bins are served by one Biofix turning machine and a travel carriage.

From the slewable feeding conveyor the waste material is transferred to the bin charging system with its charging bridge and the reversible and movable charging belt conveyor.

This conveyor automatically throws the waste material into the first section fields of each selected bin. The waste material remains in the fields under forced suction ventilation until the Biofix turning machine turns it after approx. 2 to 3 days according to the required degree of composting. The bio-waste material is turned seven times and so moves to the end of the bin.



The Biofix turning machine starts from the discharge traversing system and moves to the waste material on the top of bin walls via rails.

The loosening roller of the Biofix turning machine is lowered just above the aeration floor and scrapes into the composting material.

The material is loosened, crushed, homogenised and transferred to an inclined chain conveyor. The chain conveyor transports the composting material to a slewable chute. This chute discharges the composting material without compacting it. Using a load-controlled drive the Biofix turning machine moves through the waste material. Once it arrives at its front, the material has been turned to the rear by approx. 5.5 m on an average. Thus, the charging area of the bay is free and can be filled with fresh composting material. The chain conveyor and the loosening roller are swung upwards and the Biofix turning machine moves backwards onto the discharge traversing system. During the next turning process the composting

material lying one behind the other is turned to the rear in the same way. If the compost is on the end of the bin, the compost of the first 5.0 – 6.0 m is dumped to the rear onto conveyors in the discharge traversing system and brought to the compost collecting conveyor. This conveyor transfers the compost to the composting hall discharge conveyor which transports it to the post treatment. The discharge traversing system is also designed to move the Biofix turning machine to the front of the selected bins.

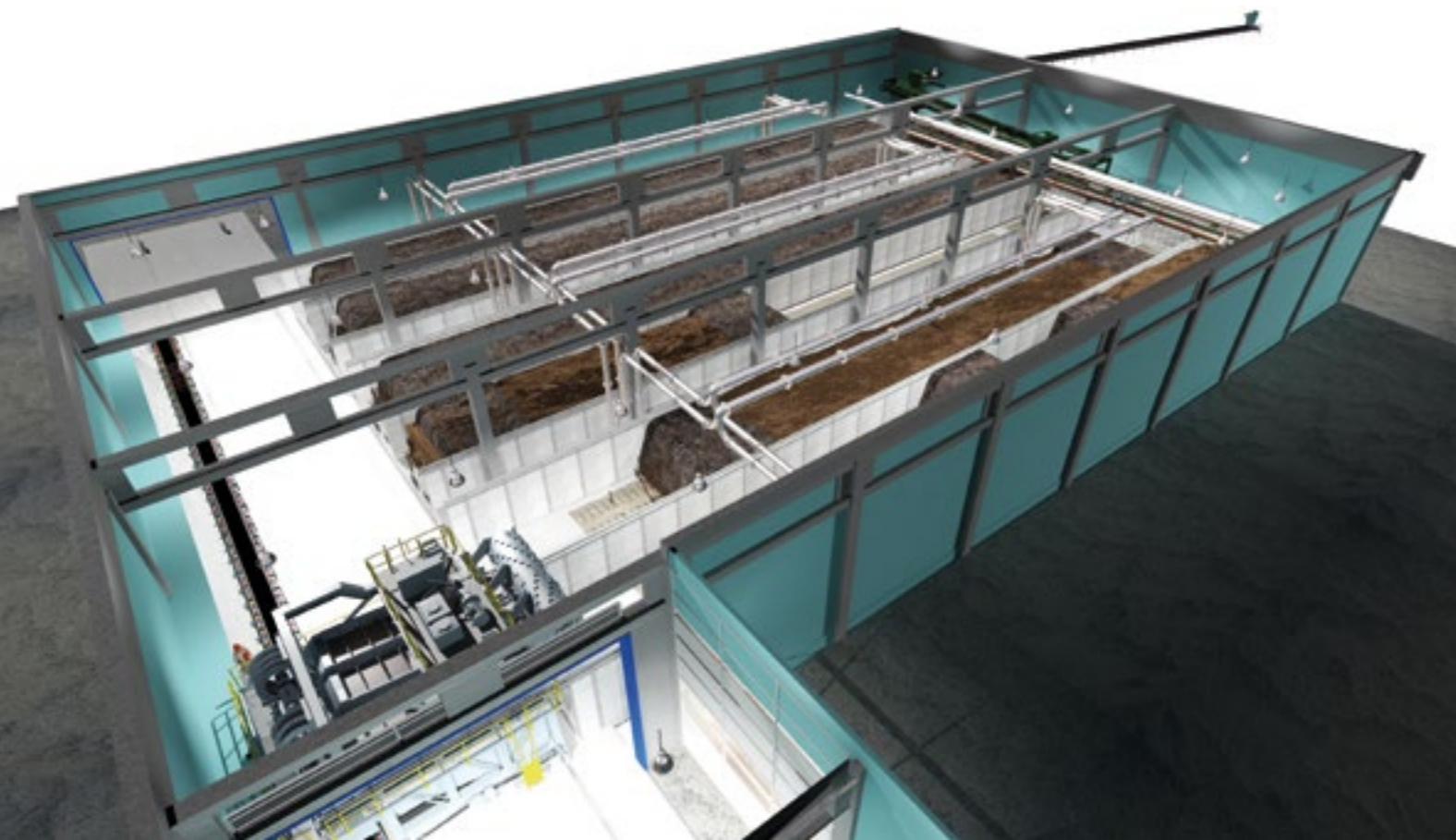

AERATION AND EXHAUST AIR CLEANING

The aeration equipment as well as the exhaust air treatment are housed in a separate operational unit in the ventilation centre. The plant areas are extracted according to the legal provisions, using several changes of air. The exhaust air of the delivery and treatment hall is conducted into the composting hall so that as little exhaust air as possible escapes into the environment from the plant.

DELIVERY/TREATMENT HALL

The delivery and treatment hall use a central hall extraction unit and miscellaneous source extraction units. A radial fan in the treatment hall is used to deliver the exhaust air from the delivery and treatment hall during times when waste is stored in the delivery hall. A multiple change of air is ensured in the hall. The air supply to the delivery and treatment hall equalling the volume of the sucked off exhaust air volume is ensured by aeration rates openings.

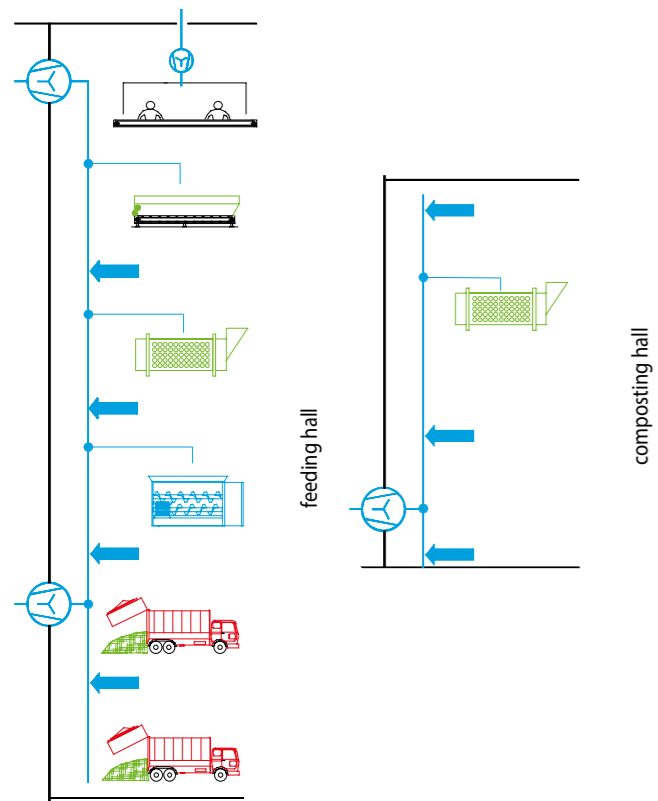

SORTING PLATFORM

The sorting platform is aerated, using a fan and an air conditioner. Thus, it is ensured that the air speed on the sorting platform is 0.2 m/sec and the personnel has not to face the blow of air. The exhaust air is conducted to the delivery and treatment hall.

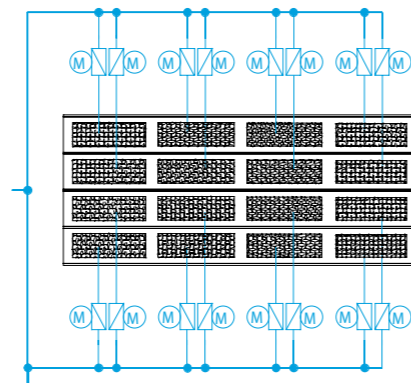

COMPOSTING HALL

The extraction of exhaust air in the composting hall is achieved through the downflow aeration in the composting bins and the extraction system within the hall. Venting to the composting bins is controlled as a function of the biological process, i.e. odour generated during the biological decomposition and CO₂ is continuously extracted.

The hall air extraction below the ceiling ensures a multiple air change rate in the composting hall in combination with the bin air suction. Supply air is delivered by a fan from the delivery and treatment hall or via over pressure louvre from the outside. A defined vacuum in the hall is ensured by a pressure control in connection with a speed control of the extraction air-fans in the hall.

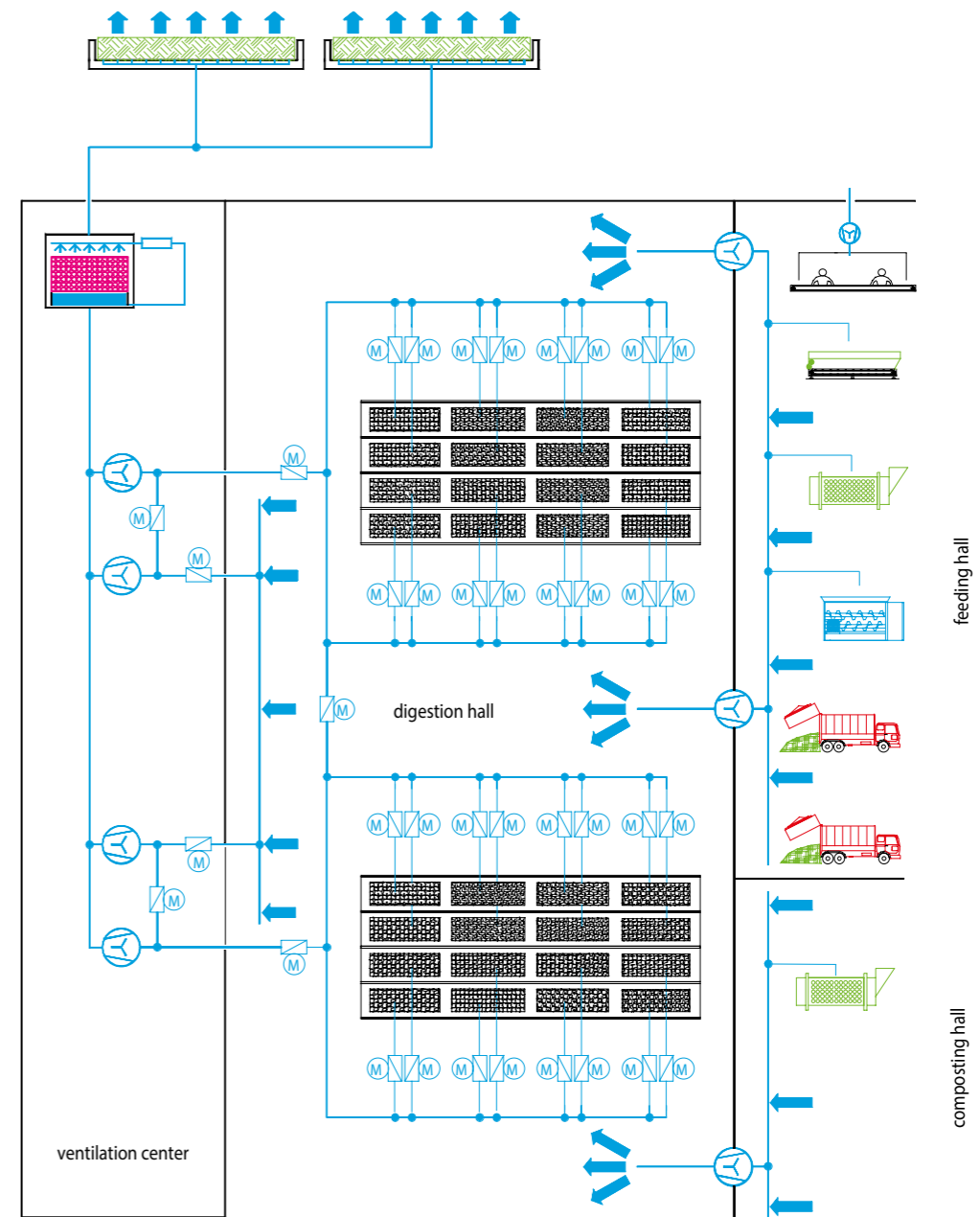
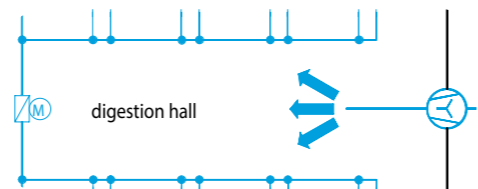

COMPOSTING

To achieve maximum decomposition rates in the biowaste material, best environmental conditions must be created for micro-organisms. To this effect, sufficient oxygen must be provided for the material to be composted among other things. Therefore, the aeration system is designed to adjust the optimum conditions in each section of the bin. During the individual composting phases the waste material is supplied with 6m³ air/m³ composting material/h on an average during the composting time. The waste material is aerated by downflow suction, and the venting process is controlled by a computer.

The aeration of the composting bins by downflow suction is via individually selectable aeration fields. The composting material lies on the ventilation tile provided with aeration openings apertures or slots. In the floor below these tiles the bin exhaust air as

well as the condensate and leachate water are collected. The bin exhaust air is delivered to the deodorizer, using headers and distributors. This is done by frequency-controlled radial fans.

Since this process water is collected together with the exhaust air, the aeration floors are provided with an individually adjusted longitudinal and cross slope. The headers and distributors of each aeration section are collected and the exhaust air is delivered to the ventilation centre. In each of the headers and distributors the air-temperature is measured to serve as a control factor. The volume flow for each aeration section can be separately controlled via motor-controlled flaps as a function in order to achieve the necessary temperature. The aeration lines have a defined slope to allow collection of the condensate water.

EXHAUST AIR CONDITIONING

Both the exhaust air flows from the composting hall and the composting bins are delivered into an air humidifier in the ventilation centre. The exhaust air is conditioned in the air humidifier by which the required humidity of the air is adjusted to 96%.



EXHAUST AIR DEODORIZATION, BIOLOGICAL FILTER

The biofilter consisting of several segments and installed in a closed hall is fed from the air humidifier. The exhaust air is delivered to the biological filter, using headers and distributors. To maintain the function of the biofilter, the filter material is changed periodically after 2 or 3 years. For such a change the filter aeration floor has a static capacity sufficient for lightweight wheel loaders.

of special clay or bark may be used. The suitable aeration floor and the careful insertion of the filter material ensure a uniform flow through the filter bed. The biofilter material is charged to the aeration fields up to a level of approx. 1,5 m. While the exhaust air flows through this filter material, the required deodorization is made. The clean air above the biofilter is collected and can escape through an exhaust air stack.

In the exhaust air duct before the biofilter the temperature and the humidity of the air stream from the composting hall and composting bins as well as the pressure loss of the biofilter are measured and recorded again. In the biofilter the air flows through a filter material containing micro-organisms. As biofilter material, compost, fibrous peat, granulate



COMPOST TREATMENT AND COMPOST STORAGE

The discharge conveyor from the composting hall feeds mature compost to the cocking-liver shaft flip flow screen. Depending on the marketing requirements, the compost is screened to the desired grain sizes, e.g. 15/25 mm. Screening residuals are thrown into a container and can either be returned to the composting process or must be landfilled or after checking them for contaminations.

The screened compost can be sold or temporarily stored in the compost storage, without any further treatment. In addition, special compost may

be produced. To this effect, the screened compost fractions are fed online to the hard material separator destoner. After a separation of the compost and the rejects ("stones") special compost is discharged from the hard material separator destoner. Using the discharge belt, the rejects are dumped to a container and must be disposed of. After the treatment the compost of the different composting degrees and the qualities are marketed or temporarily stored in a sheltered compost storage. The compost storage has a storing capacity of a 6-month compost production to balance differing needs of seasonal market periods.

The residual domestic waste remaining after employing of all waste prevention and recycling measures is considerably reduced in the MBT by a selected decomposition of the biodegradable contents, saving valuable dump space and reducing odour emissions, leachate water and the occurrence of birds-flight.

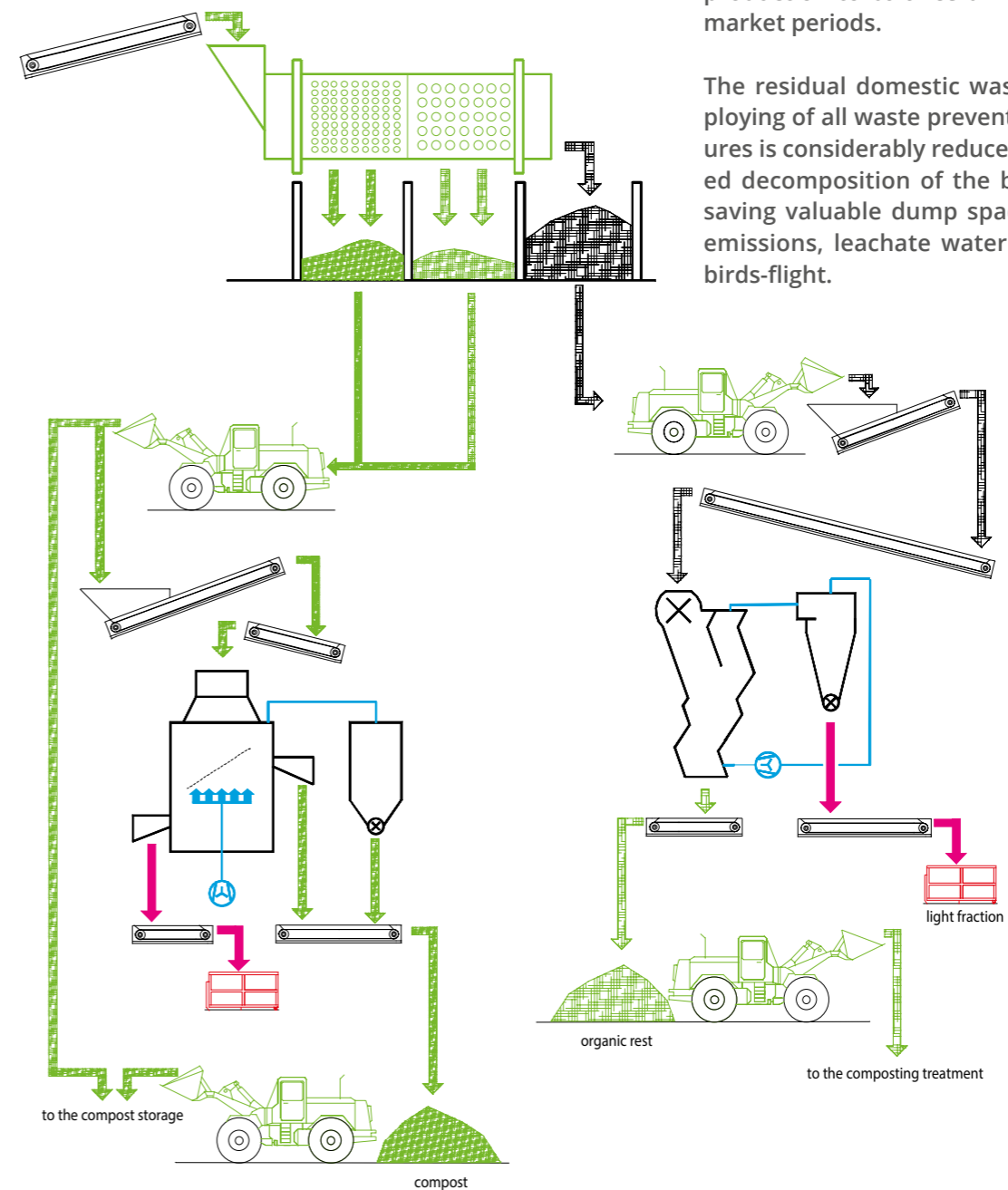

TREATMENT OF RESIDUAL DOMESTIC WASTE BIOFIX

Using wheel loaders, the delivered residual waste is conveyed to a feeding conveyor and from there into a trommel screen with a screening sector of 80 mm. The screen overflow 80 mm is conveyed through a sorting station where hazardous and reject material is sorted, and is then fed to a crusher.

Bulky domestic and commercial waste is directly fed into the crusher. The crushed material is passed to the air separator where a high calorific light fraction is separated as refuse derived fuel (RDF). This is pressed to form bales and designed for a thermal/energetic use. Together with the through material 80 mm of the trommel screen the heavy fraction passes a magnetic separator and is conveyed to homogenization trommel screen.

In this trommel screen the material is prepared for the biological stabilization by homogenization, and a fraction 140 mm is screened. The screen overflow is returned to the crusher, and the through material is charged to the composting area.

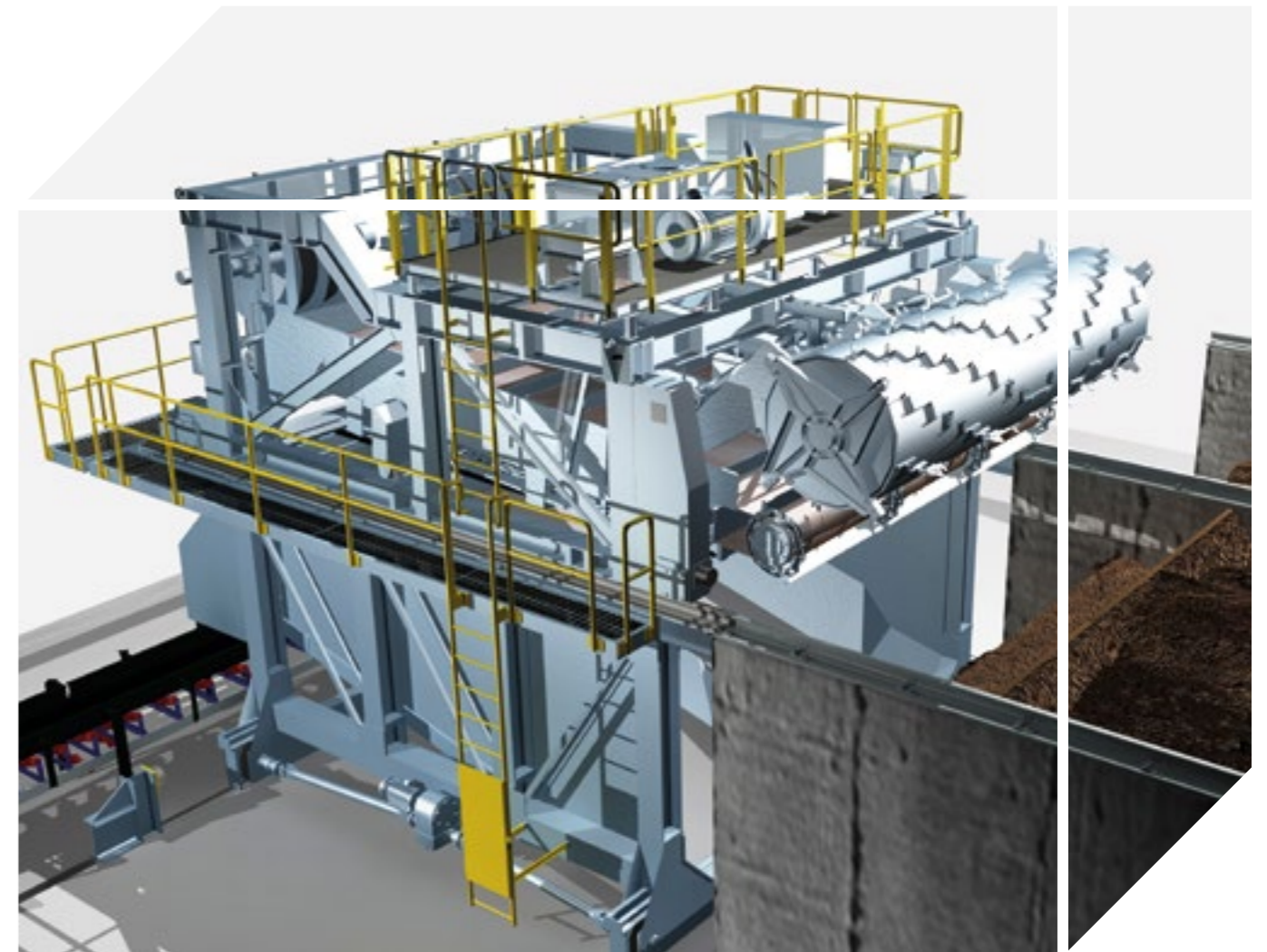
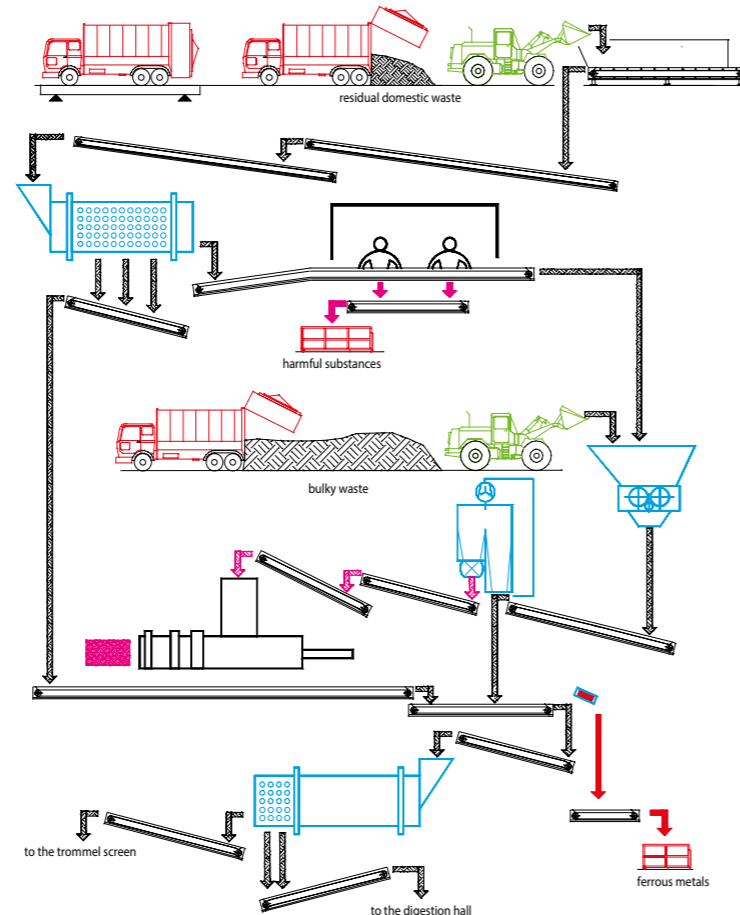

STABILIZATION OF THE WASTE

During the stabilization of residual waste the same Biofix bin composting process is used as for the composting of biological waste. While high-quality compost is produced in the biological waste composting process, the stabilization of residual domestic waste is designed to decompose the biodegradable contents as far as possible to considerably reduce odour and leachate water emissions in the landfill and to lower its volume.

The pretreated waste is treated in the Sutco Biofix bin composting process similarly to the biological waste composting process. When the material is turned by the Biofix turning machine, the composting material and the parts which cannot be digested are

further reduced in size, resulting in an additional reduction of volume in addition to the loss by evaporation during composting. At the end of the composting period the waste material may optionally be dried by superfluous aeration. The largely stabilized material discharged from the dynamic bay composting process is discharged into containers and transported to the landfill to be built into it. For the air treatment during the MBT-process similar applications are used as for the bio-waste composting process, i.e. the exhaust air of the delivery and treatment hall is collected and supplied to the composting hall. The exhaust air from the bays and the composting hall is conditioned in an air humidifier, passed through the biological filter and discharged to the atmosphere via a stack.



Sutco® RecyclingTechnik GmbH

Paffrather Str. 102-116, 51465 Bergisch Gladbach, Germany

Telefon +49 2202 2005 01

E-Mail info@sutco.de

Web www.sutco.com

WE GET THE BEST OUT.

